

**KENT**  
**Mineral RO™**  
 Water Purifiers  
 HOUSE of PURITY



 \* To request for service 24x7, download KENT Service App by scanning the QR code or by giving a missed call: 9212252852  
 To speak to customer care executive call: 92-789-12345



Marketed by:  
 KENT RO SYSTEMS LTD.  
 E-6, 7 & 8, Sector-59, Noida, U.P.-201 309, India.  
 E-mail: sales@kent.co.in | Website: www.kent.co.in

Manufactured by:  
 KENT RO SYSTEMS LTD.  
 1. Khasra No. 93, Village-Bantakhedi, Tehsil-Roorkee, District-Haridwar, Uttarakhand - 247 668, India.  
 2. A-6, Sector-87, Noida-201 305, U.P., India.

For customer complaints, contact Customer Care Officer at:  
 E-6, 7 & 8, Sector-59, Noida, UP-201 309, India. Call: 92-789-12345  
 E-mail: service@kent.co.in or visit us at www.kent.co.in

**KENT Supreme Plus**  
 Mineral RO™ Water Purifier  
 With UV Disinfection in Tank

**KENT**  
**Mineral RO™**  
 Water Purifiers  
 HOUSE of PURITY

Instruction Handbook



**KENT TECHNOLOGY**

Removes Dissolved Impurities  
 Retains Essential Minerals  
 Multiple Purification

RO + UV + UF + TDS Control + UV in Tank

Kent Deta Hai  
**Sabse Shudh Paani**

## Welcome to KENT

Dear Customer,

At the outset, allow us to thank you for your trust in **KENT** water purifier. We take pride in our reputation for product quality and industry proven performance. We are certain that your decision to own **KENT Supreme Plus Mineral RO™ Water Purifier** will go a long way towards keeping you and your family in good health. We are confident that you will be satisfied with its performance and that it will serve your need for safer and cleaner drinking water without any compromise.

This guide will help you in getting the best out of your water purifier. Please go through this booklet to familiarise yourself with its operation and maintenance.

You can look forward to years of trouble-free service. To ensure that the warranty of your water purifier is effective, it is important that you fill up the enclosed warranty card and mail us the installation report within 15 days of purchase. In case you need any further information, contact your nearest KENT dealer or branch.

Best Wishes,

**KENT RO SYSTEMS LTD.**

### Table of Contents

1. KENT TECHNOLOGY - A Breakthrough in Water Purification	1
2. Salient Features	1
3. Items in the Box	1
4. Important Instructions	2
5. Reverse Osmosis Process	3
6. UV Process	3
7. Auto-flushing System	3
8. Water Flow Diagram	4
9. Electrical Circuit Diagram	4
10. UV Fail Alarm	5
11. Filter Change Alarm	5
12. Computer Controlled Operation	5
13. Automatic Operation	5
14. Installation Instructions	6
15. TDS Adjustment	7
16. Starting-up the Purifier	7
17. Maintenance	7
18. Important Safety Instructions	8
19. Warning	8
20. Technical Specifications	9
21. Testing Information	9



## KENT TECHNOLOGY - A Breakthrough in Water Purification\*

KENT proudly presents **KENT Supreme Plus MINERAL RO™** - its new and advanced domestic water purifier which provides purer & healthier drinking water.

The futuristic **KENT Supreme Plus**, developed at KENT laboratory, broadly comprises of a state-of-the-art RO+UF+TDS Control System. The initial purification by RO membrane with porosity as fine as 0.0001 microns reduces even dissolved impurities (hard salts, heavy metals etc.). Double purification by UF membrane gives additional protection from deadly harmful micro-organisms. Moreover, the patented TDS Control System intelligently retains essential natural minerals in the purified water, thus, taking total care of your health and wellbeing.

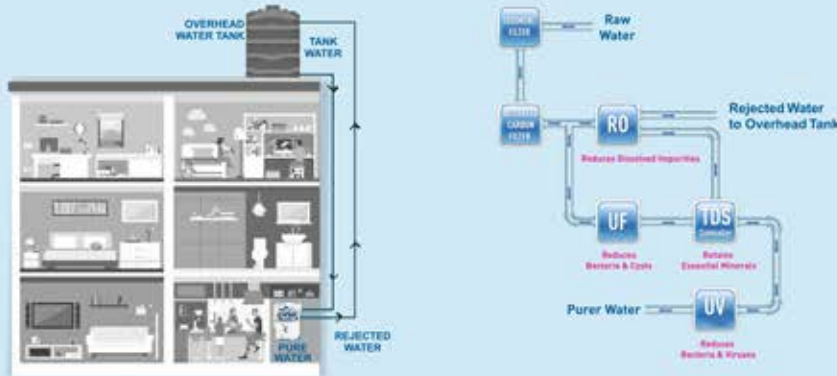

KENT is pleased to introduce **Zero Water Wastage Technology™** that recirculates rejected water to overhead tank with its own pump to make it a Zero Water Wastage RO. This unique technology helps you make water pure, without wasting any water while retaining essential minerals.

## Salient Features of KENT Supreme Plus Mineral RO™ Water Purifier









- Zero Water Wastage\*\*
- Purification by RO+UV+UF+TDS Control+UV in Tank makes water pure
- Suitable for purification of brackish / tap water / Municipal Corporation Water Supply
- Wall mounted design; best suited for Indian homes and offices
- Fully automatic operation, with auto-on and auto-off function
- Computer controlled operations for enhanced purity and long life
- RO membrane fused inside membrane housing to prevent tampering
- Vertically mounted SMPS for protection from water
- Use of push-fit fittings for leakage and maintenance free performance
- An aesthetically appealing design
- ABS construction for corrosion free use
- Inbuilt Auto-flushing system
- 8 L storage tank
- High purification capacity of 20 L/hr.

### Items in the Box

- |   |             |                              |               |
|---|-------------|------------------------------|---------------|
| 1. KENT Supreme Plus Mineral RO™ Water Purifier | : 1 No.     | 7. Fixing Clips              | : 25 Nos.     |
| 2. 3-Way Connector                              | : 1 No.     | 8. Tie Wire 4 inch           | : 4 Nos.      |
| 3. S.S. Ball Valve                              | : 1 No.     | 9. Union Connector           | : 1 No.       |
| 4. Food Grade Pipe (White) 3/8 inch             | : 25 Meters | 10. Screws & Plastic Inserts | : 2 Nos. each |
| 5. Food Grade Pipe (White) 1/4 inch             | : 20 Meters | 11. Sticker Center Drill     | : 1 No.       |
| 6. Bulk Head Union                              | : 1 No.     | 12. Warranty Card            | : 1 No.       |

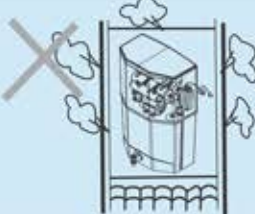
\* Tested & certified by TUV-SUD South Asia (P) Ltd. \*\*Zero Water Wastage is based on the standard testing conditions

## Important Instructions

 <p>Avoid exposure to direct sunlight and installation in damp areas.</p>	 <p>Make sure that the temperature of the water entering the purifier is within 10° C - 40° C.</p>
 <p><b>Rejected Water</b> The rejected water can be re-circulated to overhead tank for Zero Water Wastage.</p>	 <p>Maximum distance between the water source and the purifier should not be more than 3 meters.</p>
 <p>Avoid sharp bends in the pipe fittings. Do not bend or block the reject water pipe.</p>	 <p>Do not confine the purifier in a cabinet.</p>
 <p>In case of not using the purifier for more than two days, kindly switch off the power supply and drain the storage tank.</p>	 <p>To keep the storage tank clean, it should be drained once in 15 days.</p>
<p style="text-align: center;"><b>KENT</b> <b>GENUINE</b> SPARE PARTS</p> <p>Use Genuine KENT Spares for optimum performance.</p>	 <p>Do not try to service the purifier on your own. Instead, call a technician for help.</p>



## Reverse Osmosis Process

The Reverse Osmosis process, also known as hyper filtration, is the finest filtration process known till date. The process ensures reduction of particles as small as ions from a solution. Reverse Osmosis uses a semi-permeable membrane to reduce salts from potable/brackish water. In Reverse Osmosis, water pressure applied to the concentrated side forces the process of osmosis into reverse. Under enough pressure, treated water is "squeezed" through the membrane from the concentrated side to the diluted side. Salts dissolved in water as charged ions are repelled by the RO membrane.

The rejected impurities on the concentrated side of the membrane are washed away in a stream of waste water and thus do not get accumulated, as in a traditional filter.

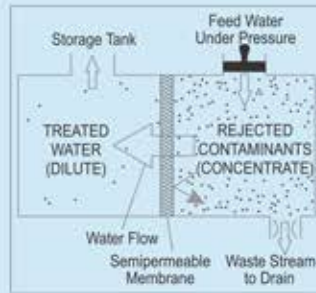

## UV Process

The UV light has shorter wavelength (higher energy) than the visible light. It is called ultra-violet because it is just beyond the violet light in the light spectrum. Technically, the ultra-violet light is defined to be any wavelength of light, which is shorter than 400 nanometer.

UV rays, which penetrate into the micro-organisms, are absorbed by the DNA of the pathogen in the water. The DNA is altered in such a way that the pathogen cannot reproduce itself. Thus, it is essentially killed and cannot cause infection. This process of DNA modification is called inactivation.

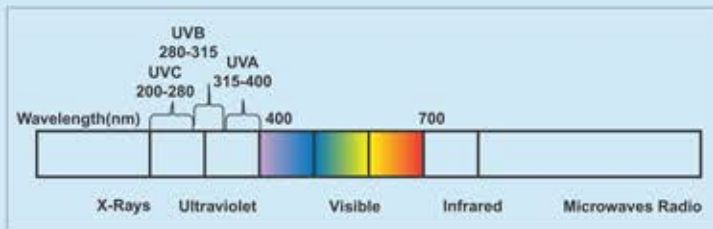

Note: The purified water stored in tank is disinfected using LED UV, which automatically switches on for 30 minutes in a two hour cycle.

## Auto-flushing System

The purpose of the Auto-flushing system is to help prevent scaling or fouling of the RO membrane by providing a rapid rinse which washes away impurities from the membrane's surface and keeps the membrane clean. It offers the following benefits.

- Lowers rejected water outflow
- Improves "TDS" rejection rate i.e increases RO membrane efficiency
- Extends life of RO membrane

## Water Flow Diagram

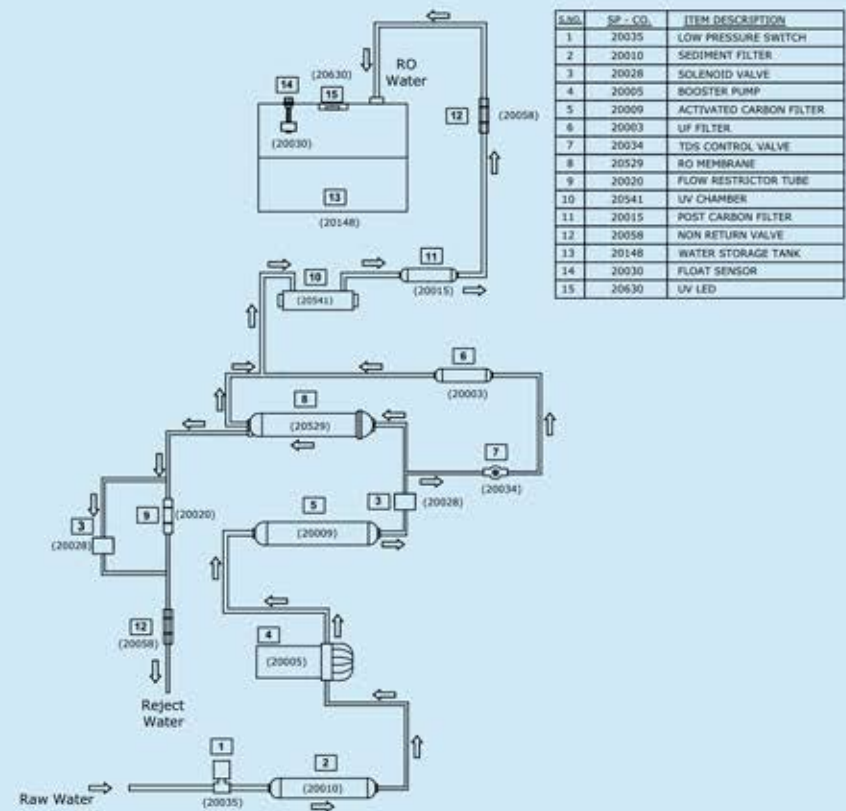

S.NO.	SP - CD.	ITEM DESCRIPTION
1	20035	LOW PRESSURE SWITCH
2	20010	SEDIMENT FILTER
3	20028	SOLENOID VALVE
4	20005	BOOSTER PUMP
5	20009	ACTIVATED CARBON FILTER
6	20003	UF FILTER
7	20034	TDS CONTROL VALVE
8	20529	RO MEMBRANE
9	20020	FLOW RESTRICTOR TUBE
10	20541	UV CHAMBER
11	20015	POST CARBON FILTER
12	20058	NON RETURN VALVE
13	20148	WATER STORAGE TANK
14	20030	FLOAT SENSOR
15	20630	UV LED

## Electrical Circuit Diagram

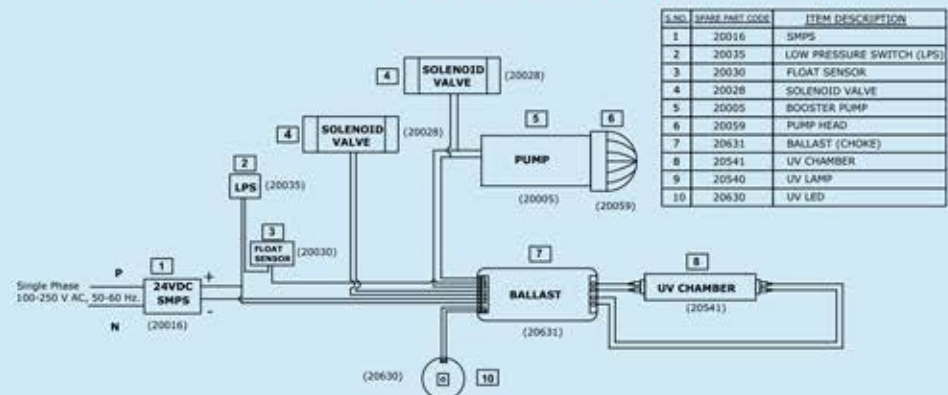

S.NO.	WIRE PART CODE	ITEM DESCRIPTION
1	20016	SMPS
2	20035	LOW PRESSURE SWITCH (LPS)
3	20030	FLOAT SENSOR
4	20028	SOLENOID VALVE
5	20005	BOOSTER PUMP
6	20059	PUMP HEAD
7	20631	BALLAST (CHOKER)
8	20541	UV CHAMBER
9	20540	UV LAMP
10	20630	UV LED



## UV Fail Alarm\*

KENT Supreme Plus Mineral RO™ Water Purifier has an in-built feature that sounds an audible alarm if the UV lamp malfunctions. This feature is provided to ensure purity. This UV Fail Alarm will sound as follows:

Single short beeps after every two seconds. The purifier will stop its purification process in such a circumstance.



In case of UV LED failure it sounds an alarm with two beeps.

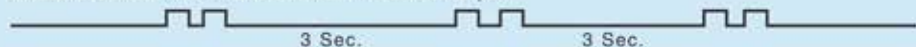

In case such an alarm is audible, call the service technician for help.

## Filter Change Alarm\*

KENT Supreme Plus Mineral RO™ Water Purifier has an in-built feature that sounds an audible alarm to indicate replacement time for filters. This alarm will be audible after 700 hrs of use since the last filter change (or since the time of installation). The Filter Change Alarm will sound as follows:

4 short beeps after every two seconds; for 30 seconds. The alarm will repeat after every 2 hours of use.



In case such an alarm is audible, please call the service technician and request him to change the filters of the purifier. However, if the filters are not changed within the next 60 hours of operation, the purifier will stop functioning to ensure purity and hygiene. The following alarm will be audible after 60 Hrs. A continuous beep for an infinite time.



In case, such an alarm is audible, kindly switch off the purifier and call the service technician to replace the filters. In such a circumstance, the purifier will not function unless the filters are changed.

## Computer Controlled Operation\*

To ensure delivery of purer and healthier water, a micro-processor is installed in the purifier that performs the following functions:

**UV Stabilization Delay:** To ensure that the UV lamp is pre-heated and is working at its optimum level before it starts disinfecting water, the controller provides a two seconds delay to UV lamp when the purifier is switched on. During this period, only the UV lamp is switched on and other electrical devices of the purifier are switched off.

**Purification Delay:** To ensure that the idle water lying in the internal pipes and in the UV chamber is disinfected before being passed into the storage tank, the system provides 5 second delay when the purifier is switched on. During this time, the UV lamp kills all micro-organisms that may be in the water inside UV chamber. After this delay, all other electrical devices such as booster pump and solenoid valve are switched on to start normal purification process.

**Audible Alarm:** The controller also controls the timing of UV Fail Alarm and the Filter Change Alarm.

## Automatic Operation

- The purifier automatically shuts off when the storage tanks are full
- The purifier automatically restarts when water level drops below the maximum
- The purifier automatically flushes & cleans the RO membrane on periodic intervals
- The purifier does not allow any water rejection in absence of electricity or when tank is full
- The purifier does not start if the inlet water supply pressure is below 0.3 kg/cm<sup>2</sup>

\* Tested & certified by TUV-SUD South Asia (P) Ltd.

## Installation Instructions

The KENT Supreme Plus Mineral RO™ Water Purifier is a product of advanced technology, which ensures safe and clean drinking water. The purifier is easy and convenient to install.

**Recommended Site Preparations:**

- Single Phase 100-250 V AC, 50-60 Hz. connection not more than 3m away from the point of installation of purifier
- Raw water supply with ½ inch nipple not more than 3m away
- Drain for rejected water not more than 3m away
- Space as per dimensions of the purifier
- Wall plane surface for mounting two screws and holding the machine
- The system and installation must comply with state and local laws and regulations

**Specific Instructions:**

- KENT Supreme Plus Mineral RO™ Water Purifier is a wall mountable purifier. Make sure that it is only mounted on a wall. Avoid installation on wooden and metallic stands
- For optimum performance and minimum inlet pressure required, ensure that the raw water supply tank is at least 10ft above the level at which the purifier is installed
- It is preferable to install the purifier near a sink so that inlet and reject water lines are easily available

**Installation Procedure:**

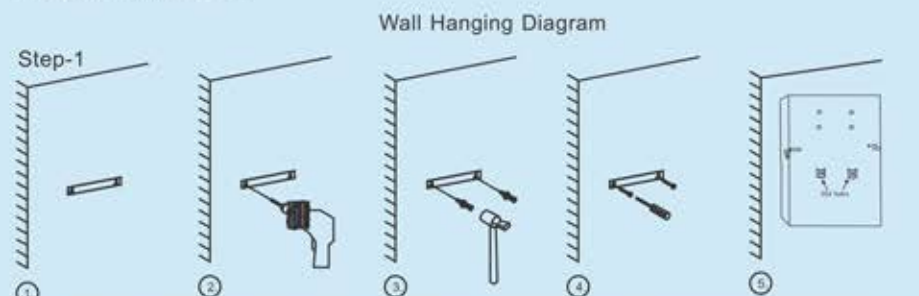

1. Paste the central drill sticker on wall at (3.6 Feet to 4.0 Feet from the ground) as per your convenience.
  2. Ensure that sticker is pasted straight on the wall, then drill holes as per the space provided on sticker.
  3. Now, insert the puff up with the help of a hammer.
  4. Screw in two 10X50 self-taping screws, 5.6 inches (142 mm) apart horizontally.
  5. Carefully hang the purifier on the wall with the help of wall-mounting slot holes provided on back side of the purifier.
- Note: If the wall is not straight or the screws are not properly drilled in an even position, it will damage your purifier.  
Note: Keep the device away from heat or direct sunlight.

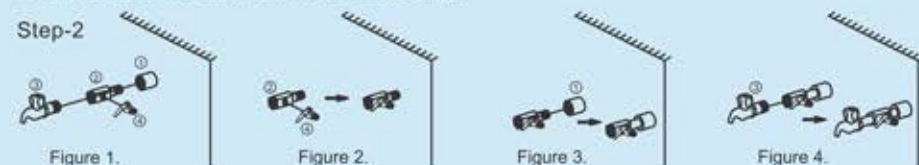

1. First fix the SS ball valve (marked as no. 4) to the 1/4 inch port of the 3-way connector (marked as no. 2) as shown in figure 2.
2. Connect the 3-way connector to the raw water supply (marked as no. 1) as shown in the figure 3. The 3-way connector is fitted in line with the raw water supply.
3. The other end of the 3-way connector can be connected to a tap (marked as no. 3) as shown in figure 4, or can be plugged off if not required.



### Step-3

1. Now connect one end of the white pipe to the SS ball valve and another end to the upper push-fit elbow fitting to the left hand side of the purifier labelled as WATER IN, as shown in fig 1.
2. Similarly, connect one end of the white pipe to the lower elbow fitting connector in tank labelled as REJECT WATER and leave the other end in the overhead tank, as shown in fig 2.

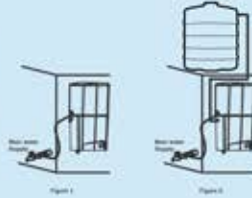

### Step-4

Before connecting the power supply, it is important that you perform the following functions:

1. Open the SS ball valve (Handle parallel to the ball valve) to start the flow of water into the purifier, as shown in the figure.
2. Wait for 2-3 minutes to ensure that the filters are soaked in water.

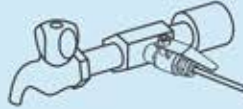

### Step-5

1. Connect the power supply.
2. Installation is complete.

## TDS Adjustment\*

A unique feature in KENT Supreme Plus Mineral RO™ Water Purifier is the TDS control valve, which is not available in any other domestic water purifier till date. This feature allows the user to control the content of natural minerals (TDS) in purified water.

To increase the TDS level, the user can turn the screw of the valve anticlockwise; it will result in more mineral content in treated water. To reduce the TDS level, user can turn the screw valve clockwise, it will result in less mineral content in treated water. We recommend the TDS of the purifier to be kept at lowest but not below 50 mg/l.

## Starting-up the Purifier

- Switch on the power supply
- Wait till the storage tank fully fills up
- Switch off the power supply
- Drain the storage tank by opening the drain plug present at the bottom of the storage tank so as to remove any dust particles present in the pipes and storage tank
- Close the drain plug & switch on the power supply
- The purifier is ready to use

## Maintenance

To ensure that the purifier operates at its optimum level, a routine maintenance must be performed. The frequency of the maintenance will greatly depend upon the raw water quality and consumption of treated water.

- Storage tank must be drained once in 2 weeks. To do so, switch off the power supply, open the drain plug at the bottom of the tank & allow the water to drain. Then screw back the plug and switch on the power supply
- Replace sediment, activated carbon & post carbon when the filter change alarm is audible OR after every 12 months. It is recommended to change the FRT when the filters are replaced
- Replace the RO membrane once in a year
- Replace the UV Lamp once in a Year
- If you are not going to use the purifier for a long time (in case you are on a holiday, tour or out of home), make sure that you disconnect the power supply, turn off the raw water supply and drain the storage tank

The reverse osmosis system contains a replaceable treatment component critical for the effective reduction of total dissolved solids and that product water shall be tested periodically to verify that the system is performing properly.

Replacement of spare parts are as under:-

-20010	SP	Inline Sediment Filter 8"
-20009	SP	Inline Carbon Filter 8"
-20529	SP	RO Membrane
-20015	SP	Post Carbon Filter (Blue)
-20003	SP	Hollow Fibre Membrane (RO)
-20020	SP	FRT 300/450

Note: Filters and membrane are consumables. Their replacement time is dependent on the quality of raw water and water consumption. They are not covered under the warranty. However, if a filter chokes within six months and a membrane within a year, it will be cleaned/repaired/replaced free of cost. Changing the filters and system inspection is available on call. The treatment capacity of RO membrane will reduce with time due to clogging of pores of membranes.

"This reverse osmosis system contains a replaceable component critical to the efficiency of the system. Replacement of the reverse osmosis component should be with one of identical specifications as defined by the manufacturer, to ensure the same efficiency and contaminant reduction performance."

## Important Safety Instructions

- If the supply cord is damaged, it must be replaced by the original part in order to avoid hazard.
- Children should be supervised to ensure that they do not play with the appliance
- This appliance is not intended for use by persons (including children) with reduced physical, sensory or mental capabilities, or lack of experience and knowledge, unless they have been given supervision or instruction concerning use of the appliance by a person responsible for their safety

## Warning

- Do not operate the UV-C emitter when it is removed from the appliance enclosure.
- Read the maintenance instructions before opening the appliance.
- The appliance must be disconnected from the supply before replacing the UV-C emitter.

## Technical Specifications

PRODUCT	KENT Supreme Plus
Product Code	11112
Product Generic Name	Water Purifier
Product Colour	White
Applications	Suitable for purification of Brackish/Tap/Municipal Corporation Water
Purification Production Rate	Upto 20 L/hr.*
Body Material	ABS Food Grade Plastic
Mounting	Wall-mounting
Dimensions(mm)	400 (L) x 250 (W) x 525 (H)
Inlet Water Pressure/Temp (Min)	0.3 kg/cm <sup>2</sup> /10°C
Inlet Water Pressure/Temp (Max)	4 kg/cm <sup>2</sup> /40°C
Min./Max. Operating pH	6.5-8.0
Filter Cartridge	Sediment, Carbon Block Filter, UF and Post Carbon
Auto-Flushing System	Yes
UV Lamp Wattage	11 W
UV LED Wattage	0.7 W
Life of UV Lamp	5000 hrs. of operation
Net Weight	8.5 kg
Storage Capacity	8 L
Maximum Duty Cycle	100 L/day
Membrane Type	Thin Film Composite RO
Booster Pump Voltage	24 V DC
Total Power Consumption	60 W
Input Power Supply	Single Phase 100-250 V AC, 50-60 Hz. 
IP Rating	IPX1

\*Treatment capacity tested for tap water having TDS level of 750 ppm at room temperature.

## Testing Information

The System has been tested according to IS 10500:2012 (Standards for drinking water as per Bureau of Indian Standards) for reduction of the hazardous substances.