

# KENT GRAND<sup>+</sup>

RO WATER PURIFIER  
FOR MOUNTING ON KITCHEN WALL

**KENT**  
RO Water Purifiers

Instruction Handbook for  
Installation, Operation and Maintenance.

Meets  
IS 16240:  
2023

**KENT**  
RO Water Purifiers



**PURITY  
IN EVERY  
DROP**

**RETAINS  
ESSENTIAL  
MINERALS**

**UV LED  
IN TANK**



Marketed by:  
**KENT RO SYSTEMS LTD.**  
E-6, Sector-59, Noida, U.P.-201 309, India.  
E-mail: sales@kent.co.in | Website: www.kent.co.in

Manufactured by:  
**KENT RO SYSTEMS LTD.**  
1) Khasra No. 93, Bantakhedi, Roorkee,  
Uttarakhand-247 668, India.  
2) A-6, Sector-87, Noida-201 305, U.P., India.  
3) A-7, Sector-87, Noida-201 305, U.P., India.

**KENT TECHNOLOGY**  
Removes Dissolved Impurities  
Retains Essential Minerals  
Multiple Purification with Purity in Every Drop  
RO + UV + UF + TDS Control + UV in Tank



Kent Deta Hai  
**Sabse  
Shudh Paani**



System Tested and Certified  
by NSF International against  
NSF/ANSI Standard 58 for  
the reduction of TDS

The Process & Purifier is Patented vide patent No.: 199716  
KENT Grand<sup>+</sup> design is registered vide registration no. 219309



Dear Customer,

At the outset, allow us to thank you for your trust in a KENT water purifier. We take pride in our reputation for product quality and industry proven performance. We are certain that your decision to own **KENT Grand+** Mineral RO™ Water Purifier will go a long way towards keeping you and your family in good health. We are confident that you will be satisfied with its performance and that it will serve your need for safer and cleaner drinking water without any compromise.

This guide will help you in getting the best out of your water purifier. Please go through this booklet to familiarize yourself with its operation and maintenance.

In case you need any further information, contact your nearest

KENT dealer or branch.

Best Wishes,

KENT RO SYSTEMS LTD.

## Table of Contents

1. KENT TECHNOLOGY - A Breakthrough in Water Purification*.....	1
2. Salient Features of <b>KENT Grand+</b> Mineral RO™ Water Purifier .....	1
3. Items in the Box.....	1
4. Important Instructions .....	2
5. Reverse Osmosis Process .....	3
6. UV Process .....	3
7. Auto-flushing System .....	3
8. Water Flow Diagram.....	4
9. Electrical Circuit Diagram.....	4
10. UV Fail Alarm* .....	5
11. Filter Change Alarm*.....	5
12. Computer Controlled Operation.....	5
13. Automatic Operation.....	5
14. Installation Instructions .....	6
15. TDS Adjustment.....	7
16. Starting-up the Purifier .....	7
17. Maintenance .....	8
18. Important Safety Instructions .....	8
19. Warning .....	8
20. Technical Specifications .....	9
21. Testing Information.....	9

## KENT TECHNOLOGY - A Breakthrough in Water Purification\*

Presenting **KENT Grand<sup>+</sup>** Mineral RO™ Water Purifier. It uses futuristic and state-of-the-art technology to provide purer and healthier drinking water.

At the heart of **KENT Grand<sup>+</sup>** Mineral RO™ Water Purifier is a Reverse Osmosis membrane with capillaries as small as 0.0001 microns that reduce even dissolved impurities (salts and heavy metals) and even converts hard water to sweet and purer drinking water. The **KENT Grand<sup>+</sup>** Mineral RO™ Water Purifier also allows the user to control the Total Dissolved Solids (TDS) level of purified water.

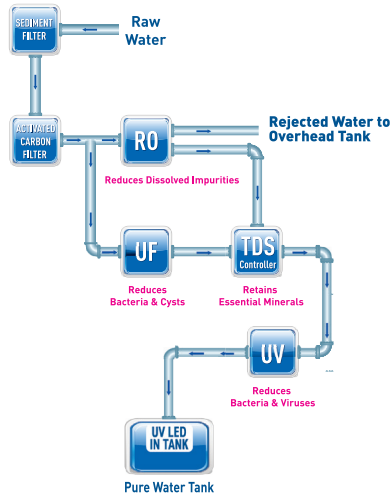

### Salient Features of

### KENT Grand<sup>+</sup> Mineral RO™ Water Purifier





- Water purifier with UV Disinfection in tank which keeps purified water pure
- Zero Water Wastage\*\*
- Purification by RO+UF+UV+TDS Control+UV in Tank.
- Suitable for purification of brackish/tap water/ Municipal Corporation Water Supply
- Wall mounted design, best suited for homes and offices
- Fully automatic operation, with auto-on and auto-off function
- Computer controlled operations for enhanced purity and long life
- RO membrane fused inside membrane housing to prevent tampering
- Vertically mounted SMPS for protection from water
- Use of push-fit fittings for leakage and maintenance free performance
- An aesthetically appealing design
- ABS construction for corrosion free use
- Inbuilt Auto-flushing system
- 9 L storage tank
- High purification capacity of 20 L/hr.
- We are not using any preservative in RO Membrane.

### Items in the Box

- |                                                       |              |                                     |                  |
|-------------------------------------------------------|--------------|-------------------------------------|------------------|
| 1. KENT Grand <sup>+</sup> Mineral RO™ Water Purifier | : 1 N        | 5. Food Grade Pipe 0.635 Cm (White) | : 2.5 Meters     |
| 2. 3-Way Connector                                    | : 1 N        | 6. Screws & Plastic Inserts         | : 2 Numbers each |
| 3. S.S. Ball Valve                                    | : 1 N        | 7. Sticker Center Drill             | : 1N             |
| 4. Food Grade Pipe 0.952 Cm (White)                   | : 2.5 Meters | 8. TDS Meter                        | : 1N             |
|                                                       |              | 9. Warranty Card                    | : 1N             |

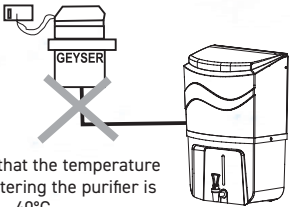
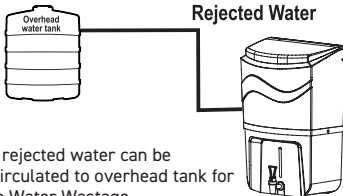
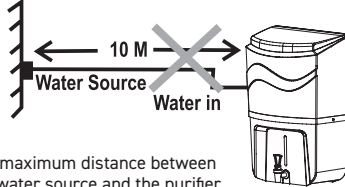
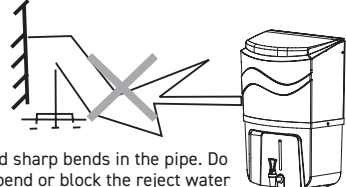
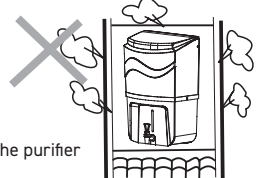
\* Tested & Certified by TUV-SUD South Asia (P) Ltd.

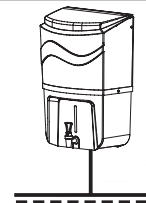
## Important Instructions

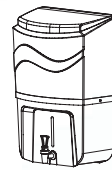
 <p>Avoid exposure to direct sunlight and installation in damp areas.</p>	 <p>Make sure that the temperature of water entering the purifier is within 10°C - 40°C.</p>
 <p>The rejected water can be re-circulated to overhead tank for Zero Water Wastage.</p>	 <p>The maximum distance between the water source and the purifier should not be more than 3 meters.</p>
 <p>Avoid sharp bends in the pipe. Do not bend or block the reject water pipe.</p>	 <p>Do not confine the purifier in a cabinet.</p>
 <p>In case of not using the purifier for more than two days, kindly switch off the power supply and drain the storage tank.</p>	 <p>To keep the storage tank clean, it should be drained once in 15 days.</p>
<div style="text-align: center;">  <p>Use Genuine KENT Spares for optimum performance.</p> </div> <div style="display: flex; justify-content: space-between; align-items: center;"> <div data-bbox="1714 1125 1847 1276">  <p>Do not try to service the purifier on your own. Instead, call service technician for help.</p> </div> <div data-bbox="1913 1117 2023 1285">  </div> </div>	

## Reverse Osmosis Process

The Reverse Osmosis process, also known as hyperfiltration, is the finest filtration process known till date. The process ensures reduction of particles as small as ions from a solution. Reverse Osmosis uses a semi-permeable membrane to reduce salts from potable / brackish water. In Reverse Osmosis, water pressure applied to the concentrated side forces the process of osmosis into reverse. Under enough pressure, treated water is "squeezed" through the membrane from the concentrated side to the diluted side. Salts dissolved in water as charged ions are repelled by the RO membrane. The rejected impurities on the concentrated side of the membrane are washed away in a stream of rejected water and thus do not get accumulated as in a traditional filter.

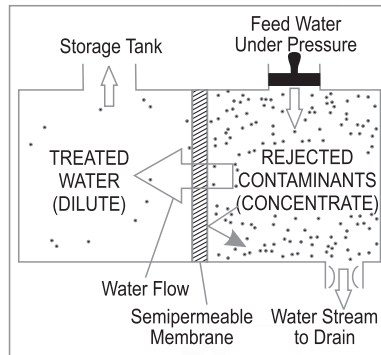

## UV Process

The UV light has shorter wavelength (higher energy) than the visible light. It is called ultra-violet because it is just beyond violet light in the light spectrum. Technically, the ultra-violet light is defined to be of any wavelength of light, which is shorter than 400 nanometer.

UV rays, which penetrate into the micro-organisms, are absorbed by the DNA of the pathogen in the water. The DNA is altered in such a way that the pathogen cannot reproduce itself. Thus, it is essentially killed and cannot cause infection. This process of DNA modification is called inactivation.

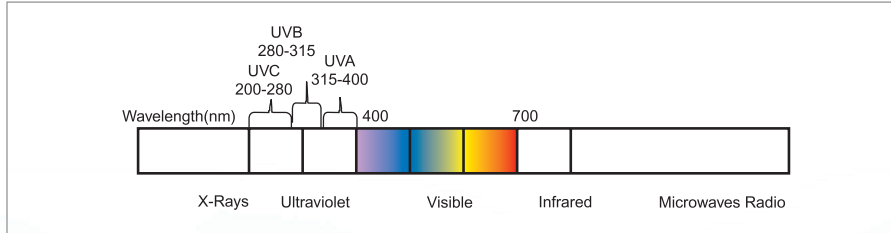

Note: The purified water stored in tank is disinfected using UV LED, which automatically switches on for 30 minutes in a two hour cycle.

## Auto-flushing System

The purpose of the Auto-flushing system is to help prevent scaling or fouling of the RO membrane by providing a rapid rinse which washes away impurities from the membrane's surface and keeps the membrane clean. It offers the following benefits:

- Lowers rejected water outflow
- Improves "TDS" rejection rate i.e increases the RO membrane's efficiency
- Extends the life of the RO membrane

## Water Flow Diagram

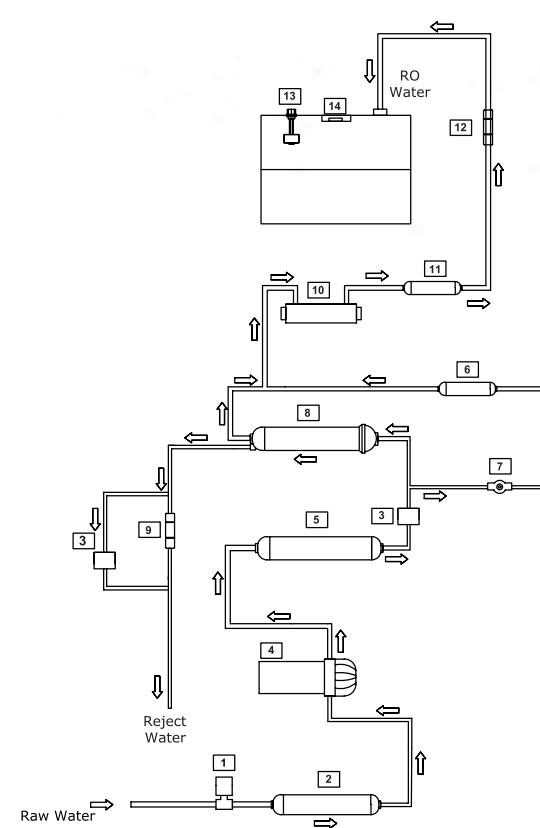

S.NO.	SP - CO.	ITEM DESCRIPTION
1	200035	LOW PRESSURE SWITCH
2	200010	SEDIMENT FILTER
3	200028	SOLENOID VALVE
4	200005	BOOSTER PUMP
5	200009	ACTIVATED CARBON FILTER
6	200003	UF FILTER
7	200034	TDS CONTROL VALVE
8	200529	RO MEMBRANE
9	202202	FRT 350
10	200541	UV CHAMBER
11	200015	POST CARBON FILTER
12	200058	NON RETURN VALVE
13	200030	FLOAT SENSOR
14	200630	UV LED

## Electrical Circuit Diagram

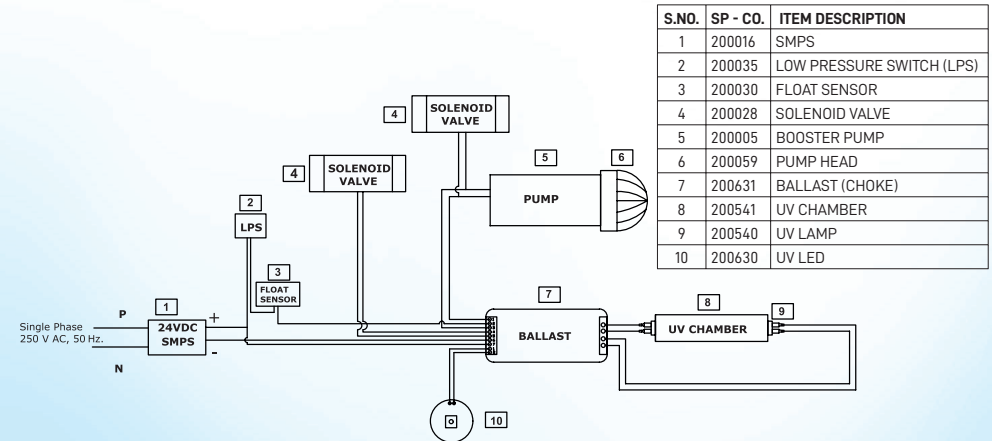

S.NO.	SP - CO.	ITEM DESCRIPTION
1	200016	SMPS
2	200035	LOW PRESSURE SWITCH (LPS)
3	200030	FLOAT SENSOR
4	200028	SOLENOID VALVE
5	200005	BOOSTER PUMP
6	200059	PUMP HEAD
7	200631	BALLAST (CHOKE)
8	200541	UV CHAMBER
9	200540	UV LAMP
10	200630	UV LED

## UV Fail Alarm

**KENT Grand<sup>+</sup> Mineral RO™ Water Purifier** has an in-built feature that sounds an audible alarm if the UV lamp malfunctions. This feature is provided to ensure purity. This UV Fail Alarm will sound as follows: Single short beeps after every two seconds. The purifier will stop its purification process in such a circumstance.

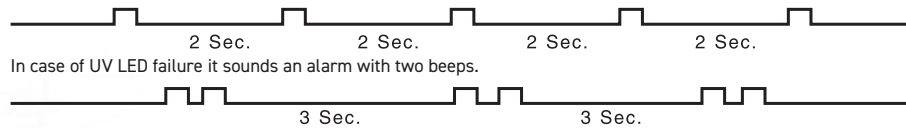

In case such an alarm is audible, call the service technician for help.

## Filter Change Alarm

**KENT Grand<sup>+</sup> Mineral RO™ Water Purifier** has an in-built feature that sounds an audible alarm to indicate replacement time for filters. This alarm will be audible after 700 hrs of use since the last filter change (or since the time of installation). The Filter Change Alarm will sound as follows: 4 short beeps after every two seconds; for 30 seconds. The alarm will repeat after every 2 hours of use.



In case, such an alarm is audible, kindly switch off the purifier and call the service technician to replace the filters. In such a circumstance, the purifier will not function unless the filters are changed.

## Computer Controlled Operation

To ensure delivery of purer and healthier water, a micro-processor is installed in the purifier that performs the following functions.

**UV Stabilization Delay:** To ensure that the UV lamp is pre-heated and is working at its optimum level before it starts disinfecting water, the controller provides a two seconds delay to UV lamp when the purifier is switched on. During this period, only the UV lamp is switched on and other electrical devices of the purifier are switched off.

**Purification Delay:** To ensure that the idle water lying in the internal pipes and in the UV chamber is disinfected before being passed into the storage tank, the system provides 5 second delay when the purifier is switched on. During this time, the UV lamp kills all micro-organisms that may be in the water inside UV chamber. After this delay, all other electrical devices such as booster pump and solenoid valve are switched on to start normal purification process.

**Audible Alarm:** The controller also controls the timing of UV Fail Alarm and the Filter Change Alarm.

## Automatic Operation

- The purifier automatically shuts off when the storage tanks are full.
- The purifier automatically restarts when water drops level below the maximum
- The purifier automatically flushes & cleans the RO membrane on periodic intervals
- The purifier does not allow any water rejection in absence of electricity/when tank is full
- The purifier does not start if the inlet water supply pressure is below 0.0344 MPa

## Installation Instructions

The **KENT Grand<sup>+</sup> Mineral RO™ Water Purifier** is a product of advanced technology, which ensures safe and clean drinking water. The purifier is easy and convenient to install.

### Recommended Site Preparations:

- Single Phase 250 V AC, 50 Hz. connection not more than 3m away from the point of installation of purifier
- Raw water supply with ½ inch nipple not more than 3m away
- Space as per dimensions of the purifier
- Wall plane surface for mounting two screws and holding the machine
- The system and installation must comply with state and local laws and regulations

### Specific Instructions:

- KENT Grand<sup>+</sup> Mineral RO™ Water Purifier is a wall mountable purifier. Make sure that it is only mounted on a wall. Avoid installation on wooden and metallic stands
- For optimum performance and minimum inlet pressure required, ensure that the raw water supply tank is at least 10 ft above the level at which the purifier is installed

### Installation Procedure:

#### Wall Hanging Diagram

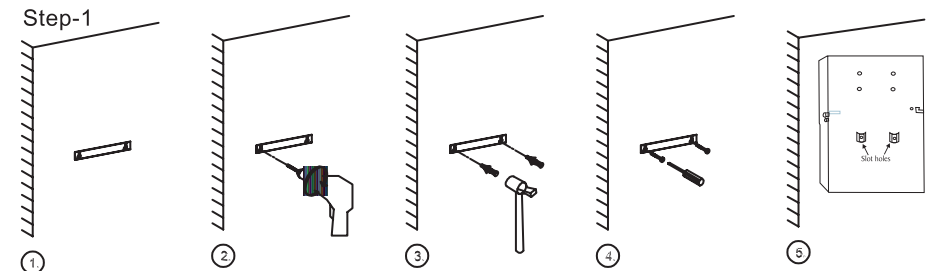

1. Paste the central drill sticker on wall at (3.6 Feet to 4.0 Feet from the ground) as per your convenience.
2. Ensure that sticker is pasted straight on the wall, then drill holes as per the space provided on sticker.
3. Now, insert the puff up with the help of a hammer.
4. Screw in two 10X50 self-taping screws, 5.4 inches (138 mm) apart horizontally.
5. Carefully hang the purifier on the wall with the help of wall-mounting slot holes provided on the back side of the purifier.

Note: If the wall is not straight or the screws are not properly drilled in an even position, it will damage your purifier. Note: Keep the device away from heat or direct sunlight.

### Step-2



1. First fix the SS ball valve (marked as no.4) to the 1/4 inch port of the 3-way connector (marked as no.2) as shown in figure 2.
2. Connect the 3-way connector to the raw water supply (marked as no. 1) as shown in the figure 3. The 3-way connector is fitted in line with the raw water supply.
3. The other end of the 3-way connector can be connected to a tap (marked as no.3) as shown in figure 4. or can be plugged off if not required.

### Step-3

1. Now connect one end of the white pipe to the SS ball valve and another end to the upper push-fit elbow fitting to the left hand side of the purifier labelled as WATER IN, as shown in fig 1.
2. Similarly, connect one end of the white pipe to the lower elbow fitting connector in tank labelled as REJECT WATER and leave the other end in the overhead tank, as shown in fig 2.

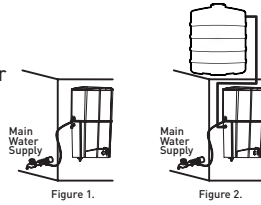

### Step-4

Before connecting the power supply, it is important that you perform the following functions:

1. Open the SS ball valve (Handle parallel to the ball valve) to start the flow of water into the purifier, as shown in the figure.
2. Wait for 2-3 minutes to ensure that the filters are soaked in water.

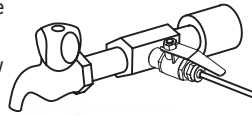

### Step-5

1. Connect the power supply.
2. Installation is complete.

## TDS Adjustment

A unique TDS Control System enables customers to retain the contents of natural minerals (TDS) in purified water as per their requirement.

- Turning the screw of the valve anti-clockwise results in increased mineral content
  - Turning the screw of the valve clockwise results in decreased mineral content
  - ➔ TDS Meter Calibration certificate frequency is yearly.
1. Firstly, remove the protective cap from the TDS
  2. Clean the cap and fill it with water. Turn on the TDS meter and dip the head of the TDS meter to test TDS level of water. Alternatively, you can also do the same procedure in the clean container to test the TDS of the water
  3. Carefully immerse the meter into the water or solution up to the maximum immersion level, which is 2 inches. Allow the display to stabilize; this takes 10 to 30 seconds. The TDS meter will automatically compensate for any temperature variations once the reading has stabilized. Now, press the hold button to save the stabilized reading.
  4. After using the meter, ensure to shake off any meter. Excess water or gently wipe it with a tissue to keep it clean and dry.

We recommend the TDS of the purifier to be kept at lowest but not below 50 mg/l.

## Starting-up the Purifier

- Switch on the power supply
- Wait till the storage tank fully fills up
- Switch off the power supply
- Drain the storage tank by opening the drain plug present at the bottom of the storage tank so as to remove any dust particles present in the pipes and storage tank
- Close the drain plug & switch on the power supply
- The purifier is ready to use

## Maintenance

To ensure that the purifier operates at its optimum level, a routine maintenance must be performed. The frequency of the maintenance will greatly depend upon the raw water quality and consumption of treated water.

- Storage tank must be drained once in 2 weeks. To do so, switch off the power supply, open the drain plug at the bottom of the tank & allow the water to drain. Then screw back the plug and switch on the power supply
- Replace sediment, activated carbon & post carbon when the filter change alarm is audible or after every 12 months. It is recommended to change the FRT when the filters are replaced
- Replace the RO membrane once in a year
- Replace the UV Lamp once in a Year
- If you are not going to use the purifier for a long time (in case you are on a holiday, tour or out of home), make sure that you disconnect the power supply, turn off the raw water supply and drain the storage tank
- Cleaning and disinfection of the storage tank by halogenated solution (usually Chlorine) or any other equivalent disinfecting method in every three months.

The Reverse Osmosis system contains a replaceable treatment component critical for the effective reduction of total dissolved solids and that product water shall be tested periodically to verify that the system is performing properly.

### Replacement of spare parts are as under:-

-200010	SP Inline Sediment Filter 8"
-200529	SP RO Membrane High Flow
-200009	SP Inline Carbon Filter 8"
-200015	SP Post Carbon Filter (Blue)
-200003	SP Hollow Fibre Membrane
-202202	SP FRT 350

Note: Filters and membrane are consumables. Their replacement time is dependent on the quality of raw water and water consumption. Changing the filters and system inspection is available on call. The treatment capacity of RO membrane will reduce with time due to clogging of pores of membranes.  
 "This Reverse Osmosis system contains a replaceable component critical to the efficiency of the system. Replacement of the reverse osmosis component should be with one of identical specifications as defined by the manufacturer, to ensure the same efficiency and contaminant reduction performance."

## Important Safety Instructions

- If the supply cord is damaged, it must be replaced by the original part in order to avoid hazard
- Children should be supervised to ensure that they do not play with the appliances
- This appliance is not intended for use by persons (including children) with reduced physical, sensory or mental capabilities, or lack of experience and knowledge, unless they have been given supervision or instruction concerning use of the appliance by a person responsible for their safety

## Warning

- Do not operate the UV-C emitter when it is removed from the appliance enclosure
- Read the maintenance instructions before opening the appliance
- The appliance must be disconnected from the supply before replacing the UV-C emitter

## Technical Specifications

Product	KENT Grand+
Product Code	111099
Product Generic Name	RO Water Purifier
Colour	White
Applications	Suitable for purification of Brackish/ Tap/Municipal Corporation Water
Weight	8.60 kg
Purification Production Rate	20 L/hr.*
Body Material	ABS Food Grade Plastic
Mounting	Wall-mounting
Dimensions(mm)	400 (L) x 230 (W) x 540 (H)
Recovery Rating (Min.)	40%
Reject Water Generation (Max.)	60%
Maximum Operatable Feed Water TDS	1500 mg/liter
Filter Cartridge	RO Membrane, Sediment filter, Activated Carbon Filter & Post Carbon
UV Lamp Wattage	11 W
UV LED Wattage	0.7 W
Life of UV Lamp	5000 hrs. of Operation
Operating Pressure (Min./Max.)	0.0344 Mpa - 0.03792 Mpa
Min./Max. Operating pH	6.5-8.0
Storage Capacity	9 L
Maximum Duty Cycle	100 L/day
Membrane Type	Thin Film Composite RO
Booster Pump Voltage	24 V DC
Total Power Consumption	60 W
Input Power	Single Phase 250 V AC, 50 Hz 
IP Rating	IPX1

\*Purification capacity tested for raw water having TDS level of 1500 ppm at room temperature.

## Testing Information

The System has been tested according to IS 16240:2023 (Standards for drinking water as per Bureau of Indian Standards) for reduction of the hazardous substances.

## Performance Data Sheet KENT Grand+ Mineral RO™ Water Purifier

"This system has been tested according to NSF/ANSI 58 for reduction of the substances listed below. The concentration of the indicated substances in water entering the system was reduced to a concentration less than or equal to the permissible limit for water leaving the system, as specified in NSF/ANSI 58".

Substance	Influent challenge concentration mg/L	Maximum permissible product water concentration mg/L	"Minimum % Reduction"
Total Dissolved Solids	750 ± 40 mg/L	187	86.80%

"Do not use with water that is microbiologically unsafe or of unknown quality w/o adequate disinfection before or after the system".

The replacement component, 200010 SP Inline Sediment Filter 8, 200009 SP Inline Carbon Filter 8, 200529 SP RO Membrane High Flow, 200015 SP Post Carbon Filter (Blue), 200003 SP Hollow Fibre Membrane, 202202 SP FRT 350, Can be purchased directly from the manufacturer KENT RO SYSTEMS LTD.